

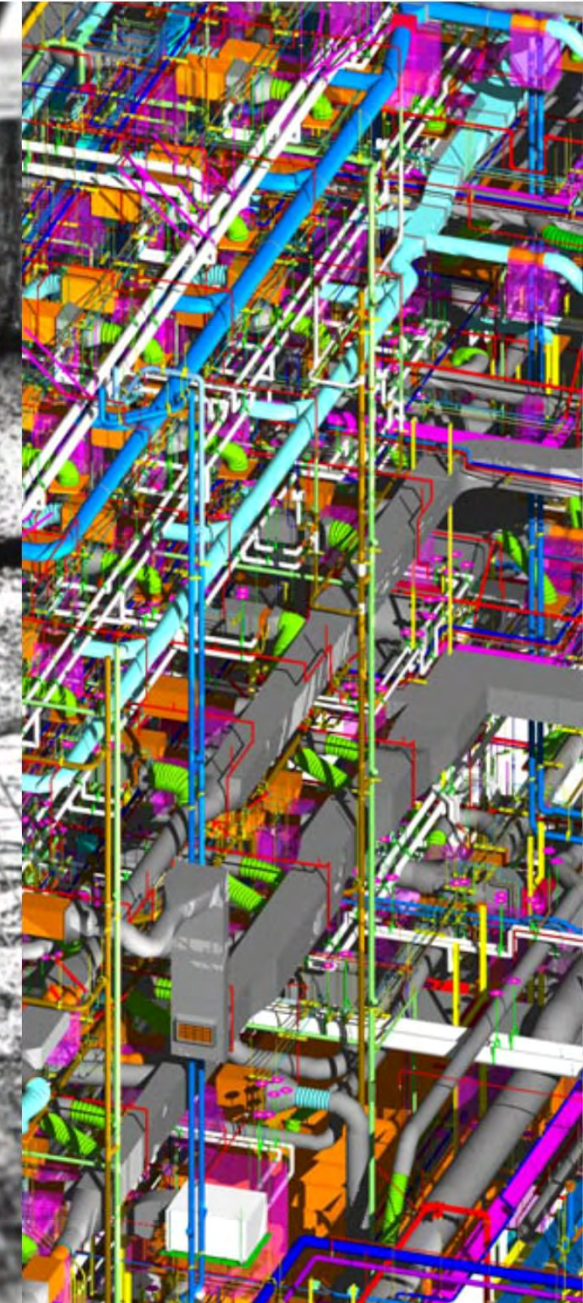

at additive
tectonics

If we want to solve the real issues in our world...



Key Issues

- creating monotonous architecture
- with unimagined amounts of waste and energy
- using a decreasing labor force
- unable to handle digital planning complexity.

...we need to drastically change the way we create our built environment.

The Additive Tectonics Approach

- Enabling innovative architectural solutions through additive manufacturing
- Optimization of designs with lightweight engineering for material efficiency and multi-function simulations for intelligent prefabricated building parts
- Circular no-waste production cycle and ability to up-recycle construction waste
- Broad range of sustainable material choices and ability to change and adopt material mixtures
- Full control of the design-to-production pipeline by integrated production cybernetics and robotics.



So we reimagined a radically new design-to-build process:

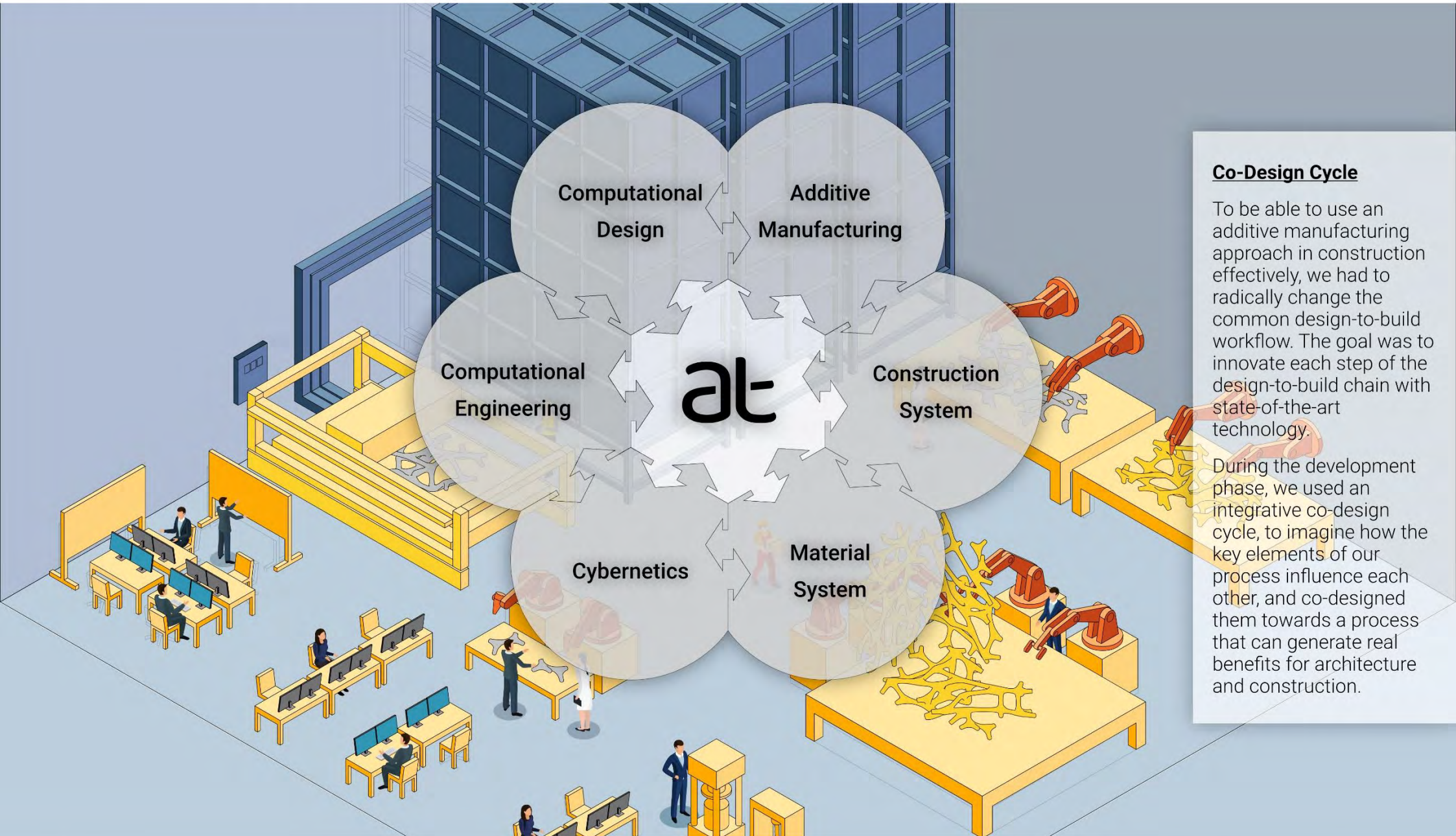

Co-Design Cycle

To be able to use an additive manufacturing approach in construction effectively, we had to radically change the common design-to-build workflow. The goal was to innovate each step of the design-to-build chain with state-of-the-art technology.

During the development phase, we used an integrative co-design cycle, to imagine how the key elements of our process influence each other, and co-designed them towards a process that can generate real benefits for architecture and construction.

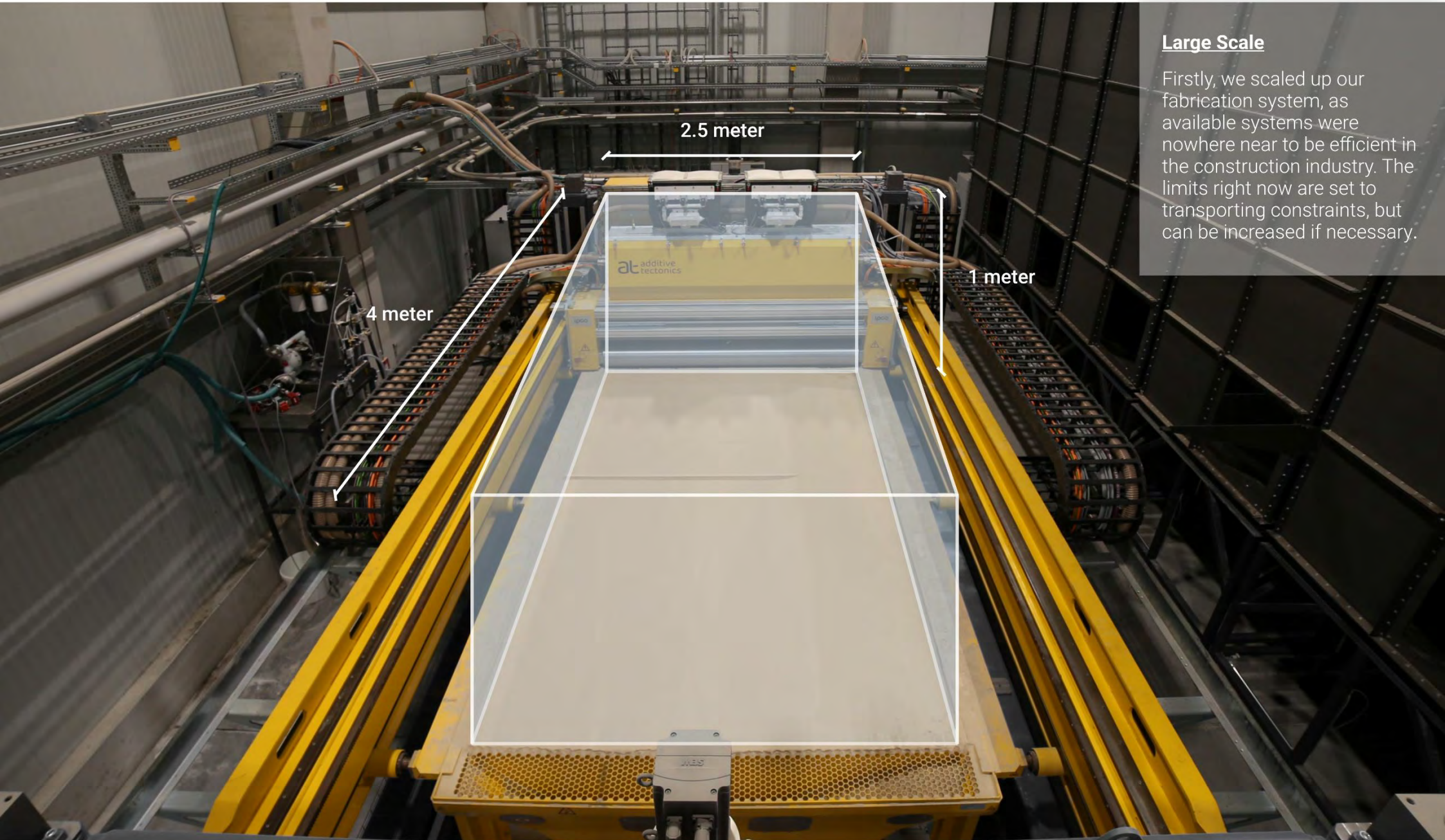

Large Scale

Firstly, we scaled up our fabrication system, as available systems were nowhere near to be efficient in the construction industry. The limits right now are set to transporting constraints, but can be increased if necessary.



Top Speed with High Precision

To keep costs down, we had to achieve an intense performance goal.

Our system today can fabricate a volume of 10m³ (one printing job) in 6 hours, which is by far the most high-performance 3D-printer in the world, without even considering the resolution of up to 1 millimeter.

Downtime between jobs is almost nullified, as build platforms are changed in an instant.

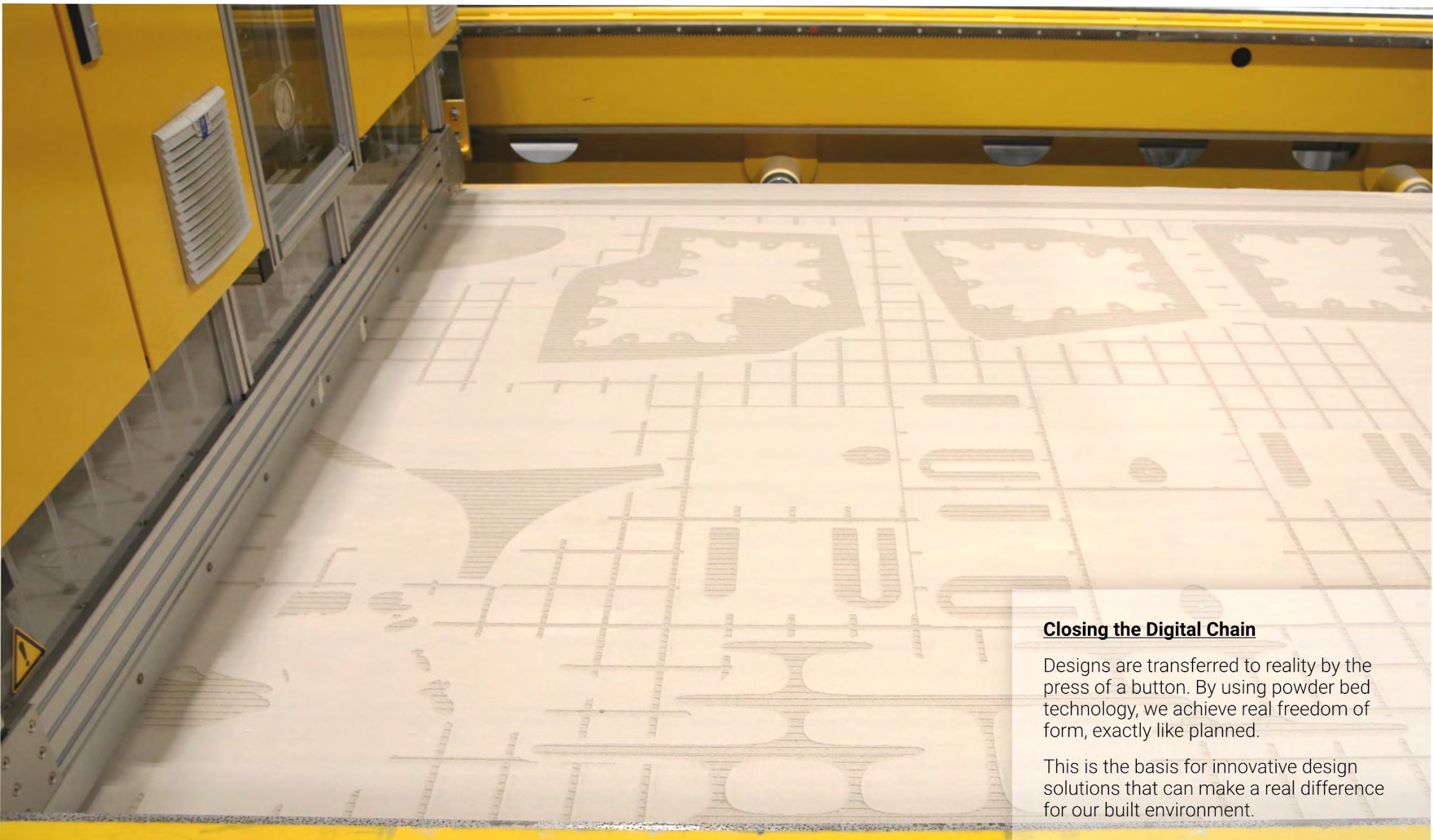

Closing the Digital Chain

Designs are transferred to reality by the press of a button. By using powder bed technology, we achieve real freedom of form, exactly like planned.

This is the basis for innovative design solutions that can make a real difference for our built environment.

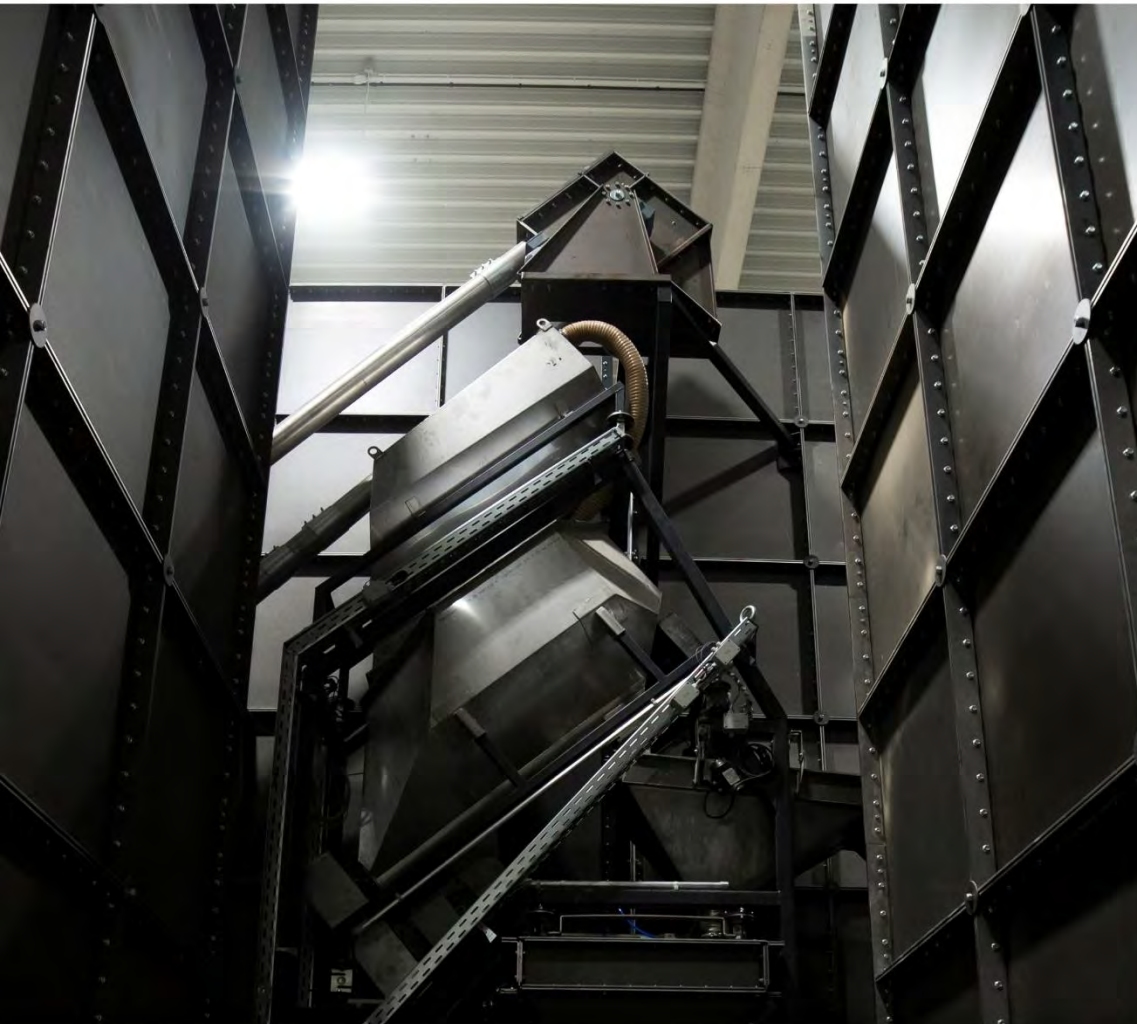

Material Performance

Innovation sometimes needs to happen by controlling the important screws. So we developed an additive cybernetics system for construction applications and materials. We control and monitor each little parameter that may influence the manufacturing, material deposition, or mixing performance in our system to ensure top notch quality and a scalable system.

Dolphin - [Monitoring AGH3System]
Monitoring Tracking Extras Hilfe

2.18.2_21/ 20.11.20:

AGH3System

Daten und Datum

Anzahl
87187

Neueste
604450

Datum
Fr 27.11.

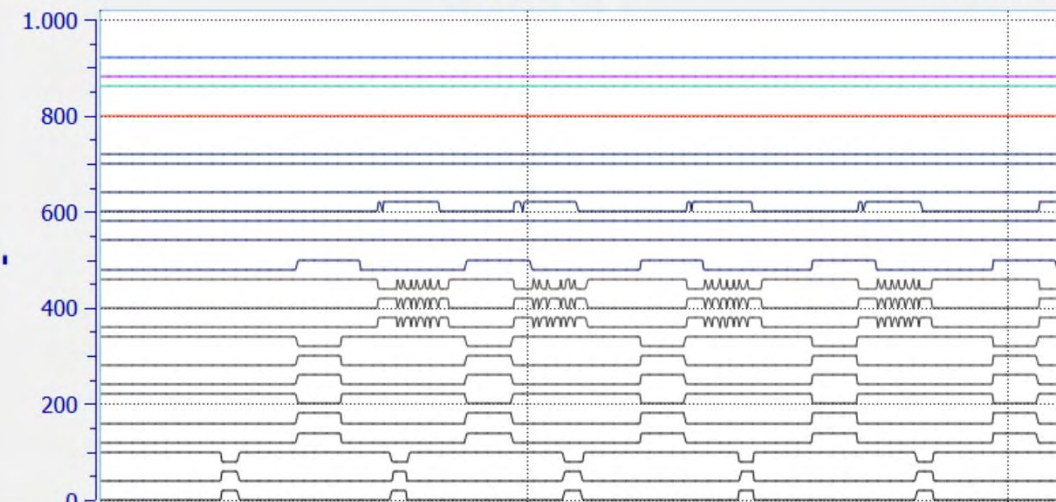
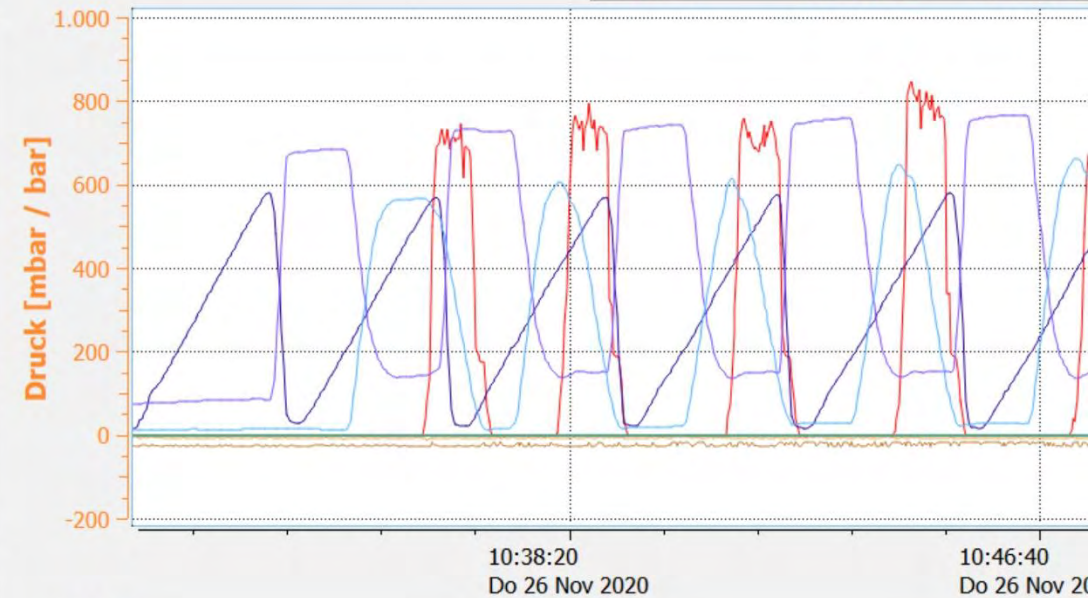

A Hungry Beast

The faster the system – the more food it needs. Our machine can devour the volume of our 12 silos easily in 10 days.



0-waste production

Every grain counts!

The powder bed gets reused for later batches, while finished parts can be used in the raw or undergo surface treatment.



Part Handling on a New Scale

Before the actual geometry is created, the algorithm divides the structure into fabricatable panels, taking into account construction and fabrication restrictions for each individual panel.

Finally we will fabricate 636 different panels, each of them around 5 m² in Dimension.



econit



Wood



Brick



Quartz



Lime

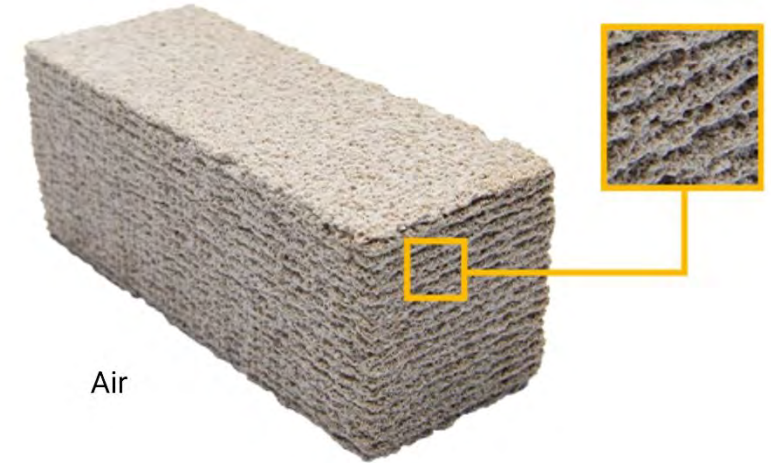

Air



Material Magic

Econit is a novel sustainable material system at the intersection of additive manufacturing and building construction.

As a base material, econit can bind a wide variety of aggregates, even in large quantities, and through targeted admixing gains a variety of aesthetic, functional, and technical properties.

Examples of aggregates are sand, brick chippings, expanded clay and expanded glass granulate, fireclay, recycled earth, and natural materials such as wood chips.



Up-Cycling

For our production line, we use mostly recycled aggregates.

Econit Air, for example, is made of expanded glass that can't be used for the production of bottles anymore.

This allows us to up-cycle waste material into high-tech building elements.



Manufacturing Performance

By grinding our material to the right grain sizes, we ensure reliable manufacturing performance. Every material parameter needs to be controlled in order to achieve a material mixture that fulfills our standards.

Material Data Tailoring

With functional properties that are similar to the parameters of cement (and sometimes even exceeding them), econit can be tailored for example with regard to density, compressive strength, heat and sound insulation, and much more.



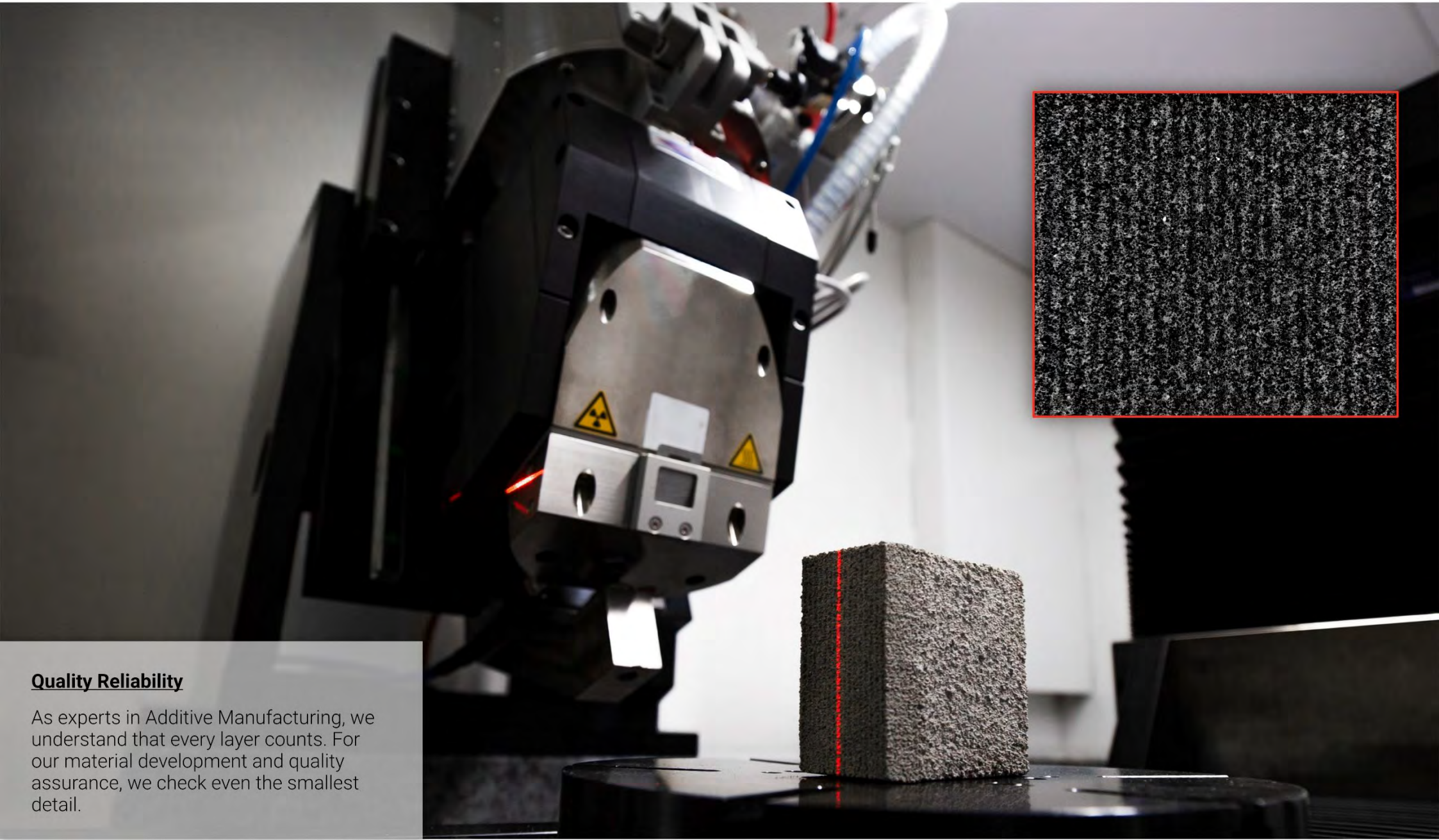

Quality Reliability

As experts in Additive Manufacturing, we understand that every layer counts. For our material development and quality assurance, we check even the smallest detail.

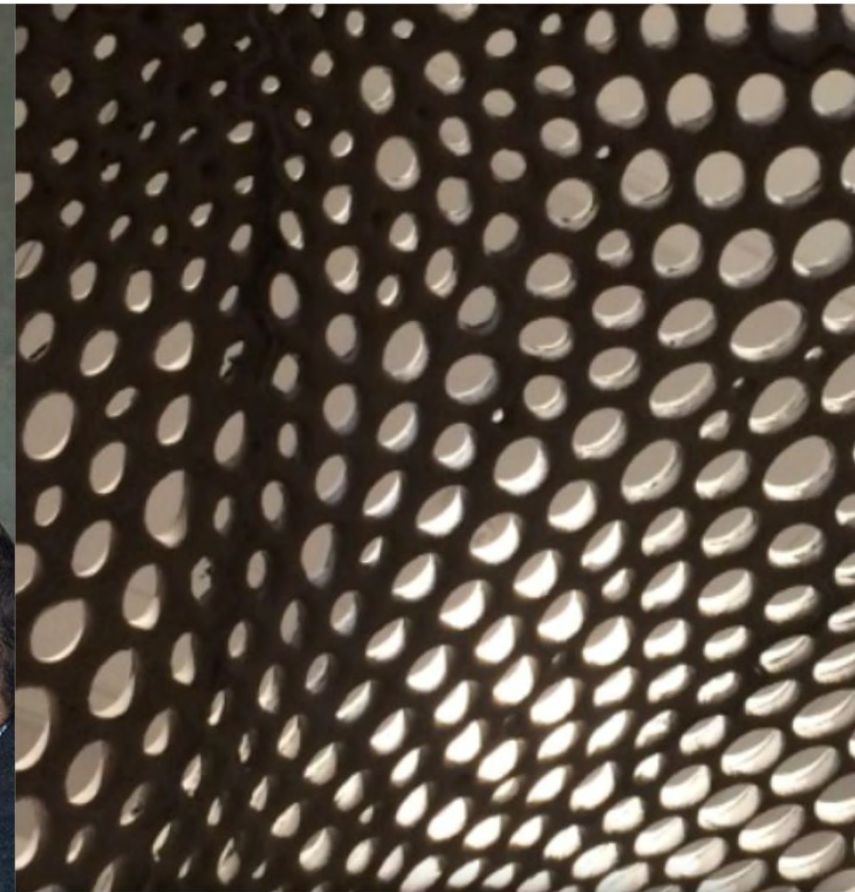

Material-Efficient Design

Nowadays, material has to be treated like a rare good.

Through the freedom of form, we have the possibility to save incredible amounts of material, as we can, for example, adapt lightweight shapes and structures from nature and apply them to our buildings.

This can lead to stunning results in performance and aesthetics.

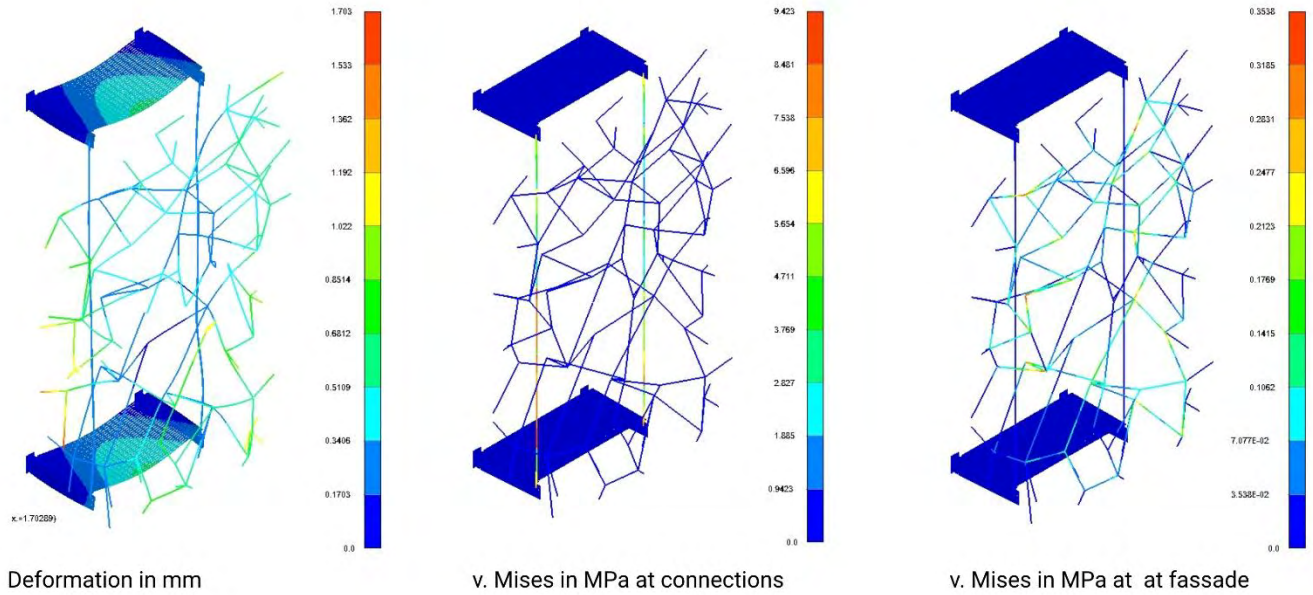

Digital Approach

'Digital' is our native language. We are already comfortable using our algorithms for race car optimization or rocket engineering. But this time, we apply them to make our buildings lighter, stronger, more efficient, or simply breathtaking.

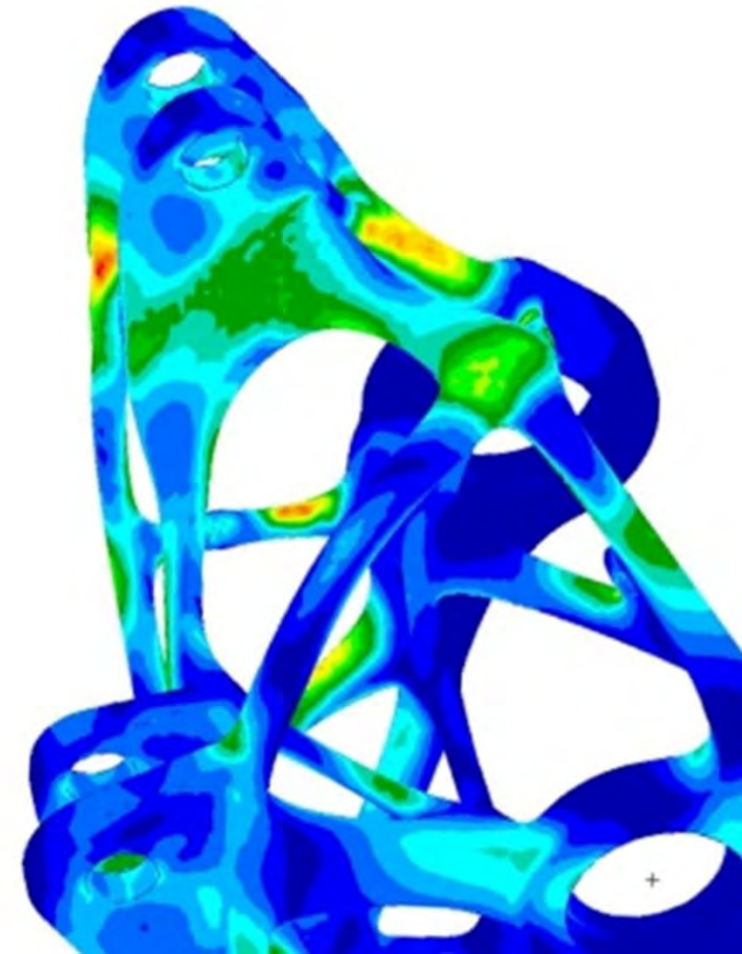
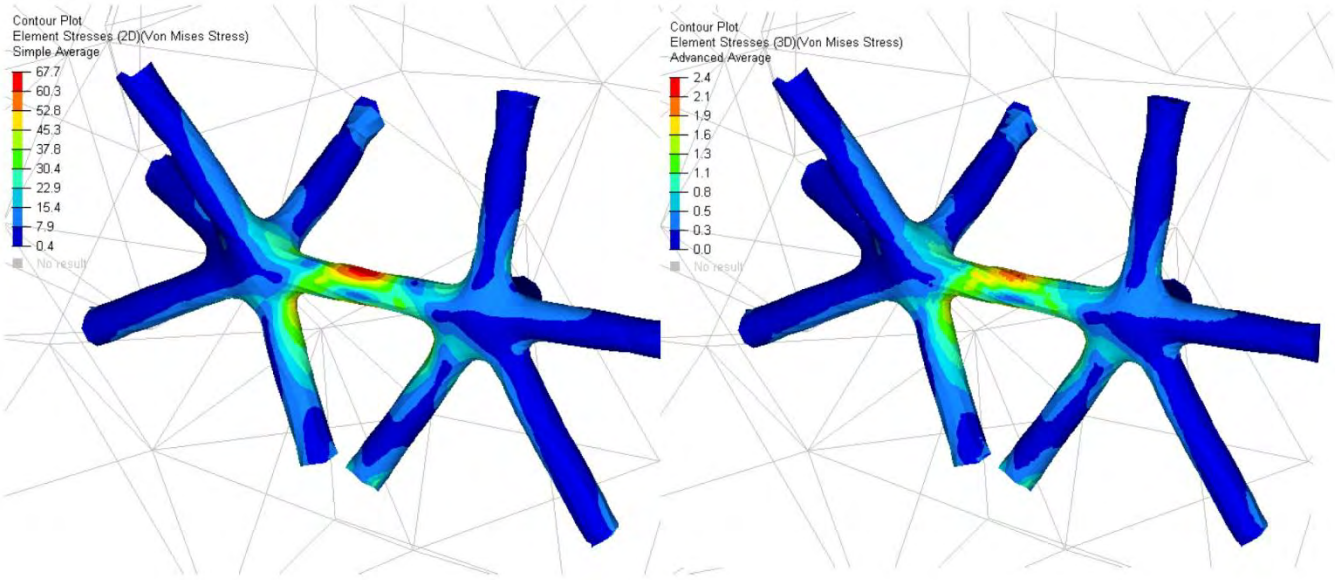



Complexity and Precision

Complex structures will enhance structural, thermal, or functional properties of a building element.

At the same time our high precision manufacturing ensures that everything still fits together perfectly, no matter the complexity.

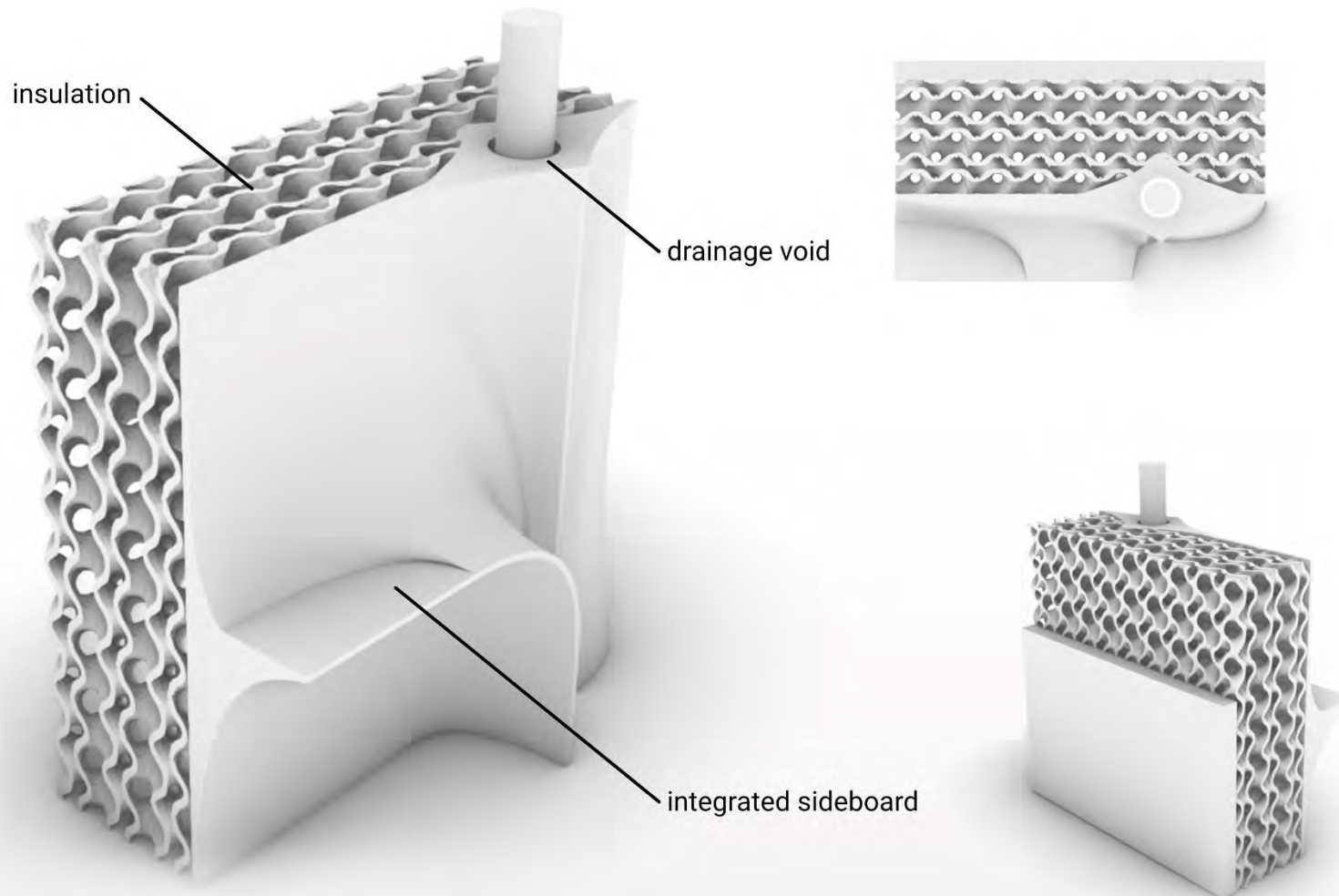

Multi-Functional Building Elements

Smart building parts can fulfill more requirements while producing less waste. With mono-material usage but bespoke structures, parts can become very good to recycle while performing excellently.

In this example, we use the exterior area as a way to seamlessly integrate usable furnishings. The interior of the part serves as a volume to integrate drainage or load bearing elements and, by increasing the surface area, as a very performant insulation.

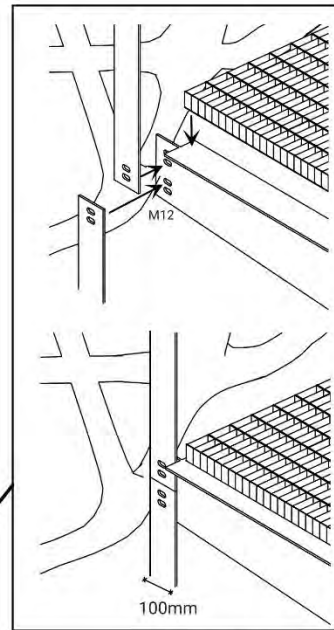
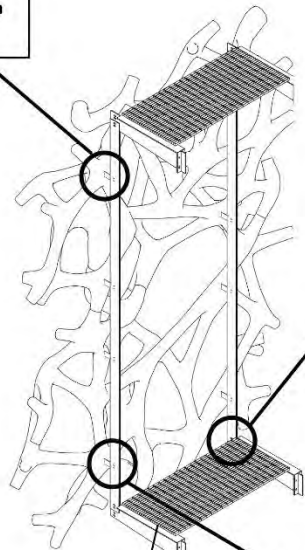

Träger für Wartungssteg

Gitterrost 1320 x 616mm
(Raster 30 x 11 x 20mm)

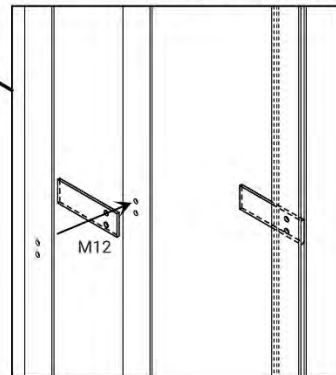

Verbinderkonstruktion

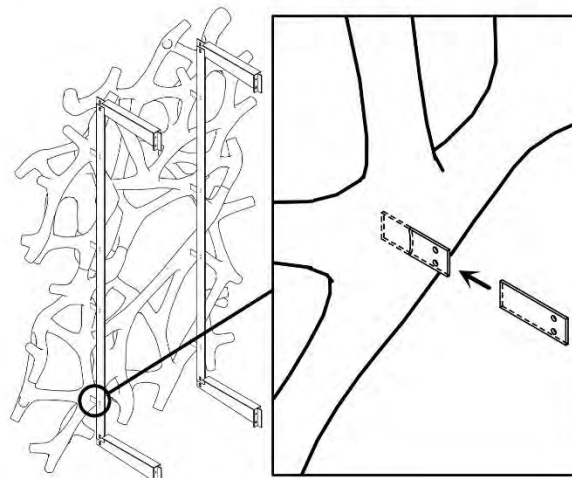
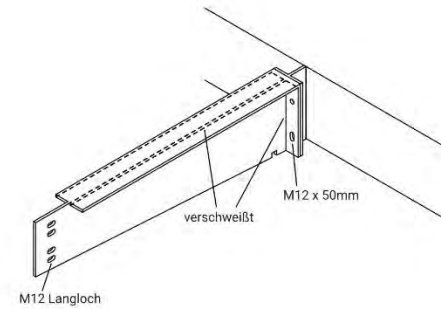
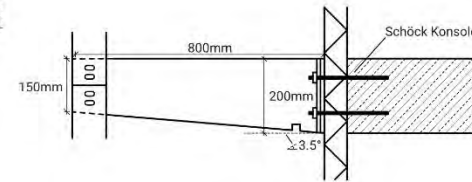
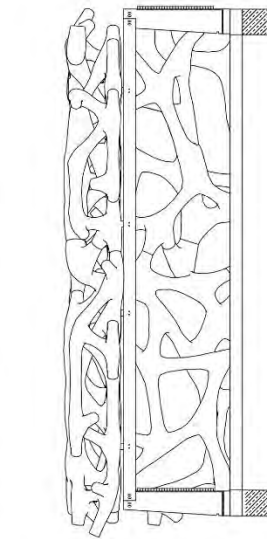

Verbinderkonstruktion

Informed Parts

To make — human or robot — assembly as easy as possible, we can provide each part with assembly information that is crucial for a streamlined construction site.

This information is taken directly from the custom software and is printed into the part with a QR-like code.

Custom Algorithms for Additive Manufacturing in Architecture

We developed a series of algorithms that enable the creation of breathtaking functional and lightweight architecture.

These algorithms not only take into account engineering and design inputs, but also check for feasibility and instantly calculate costs for a digital design.



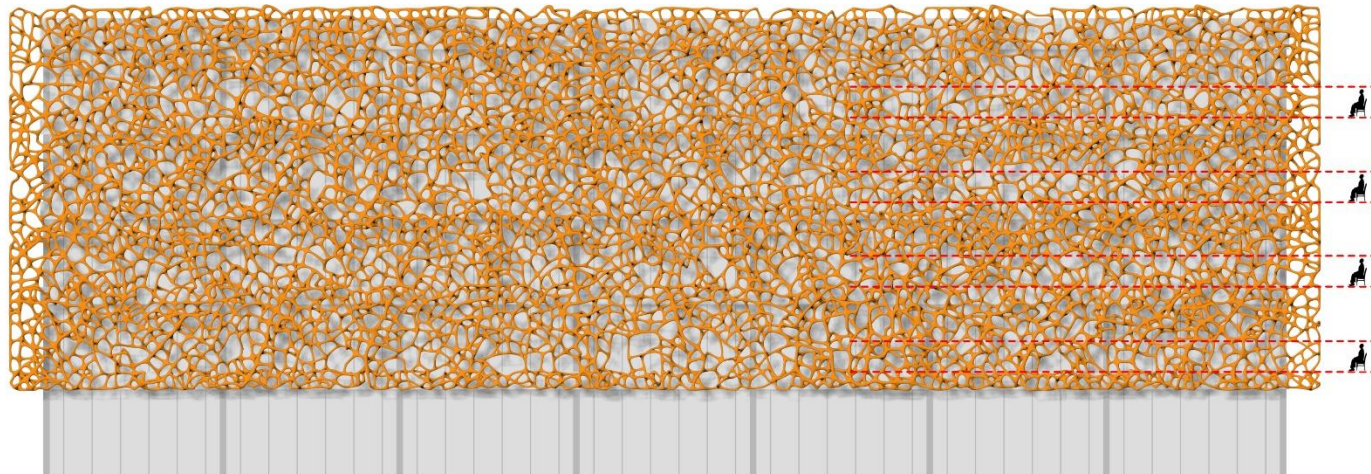
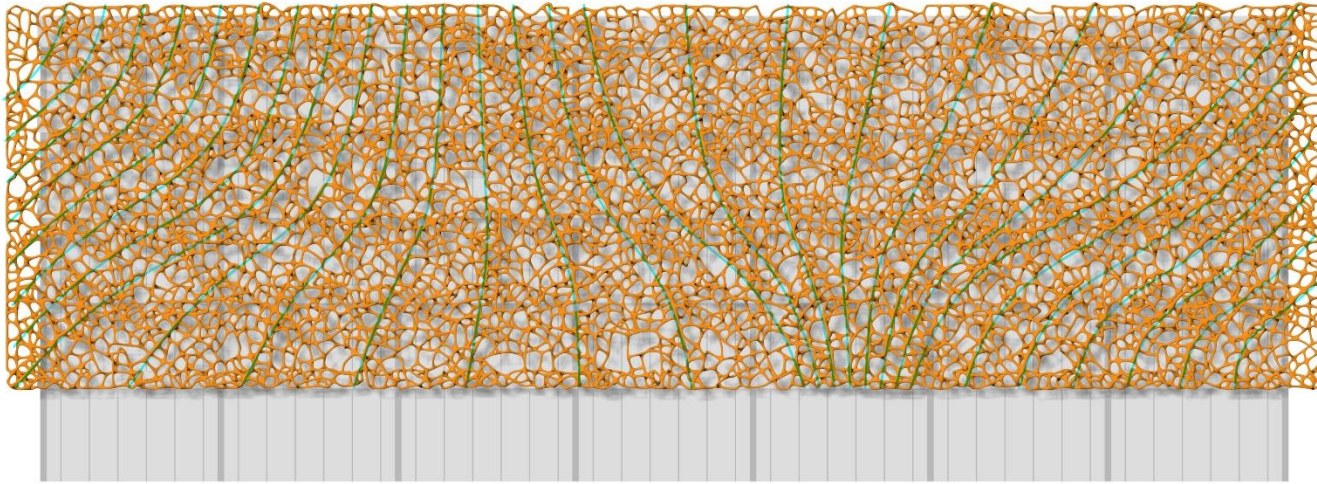

Controlling the Algorithm

Our algorithms are made to be used by architects, designers and engineers alike, as we believe that only an integrative workflow can lead to innovative solutions.

For this soon to be realized project, we integrated architectural articulation into the code for functional purposes.

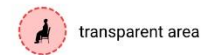
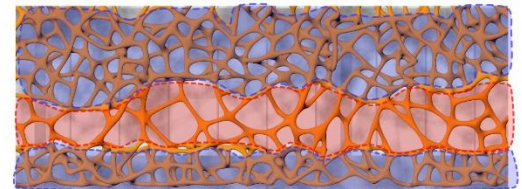
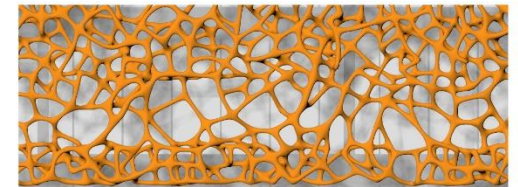

transparent area



opaque area















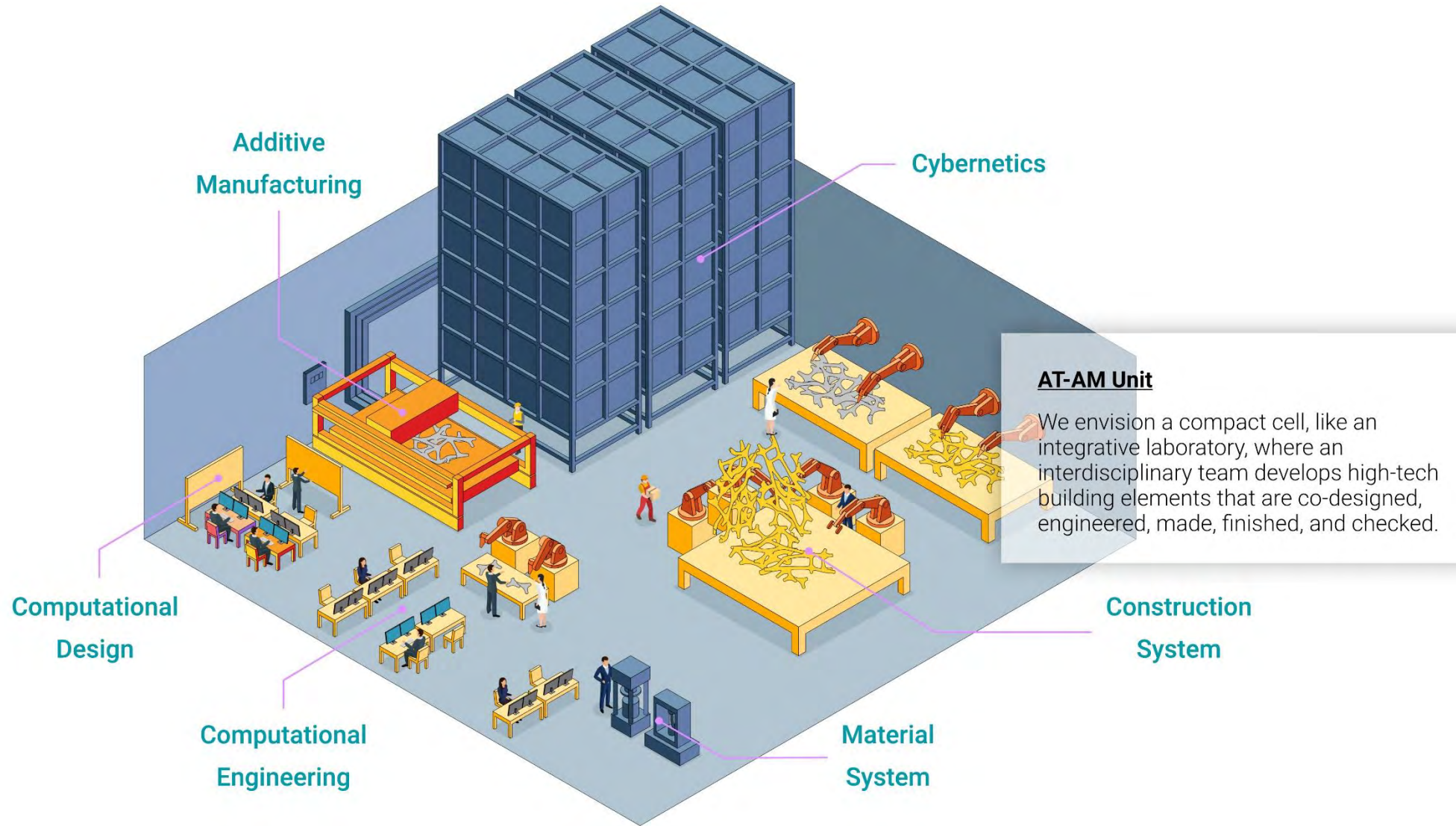



Material Processing

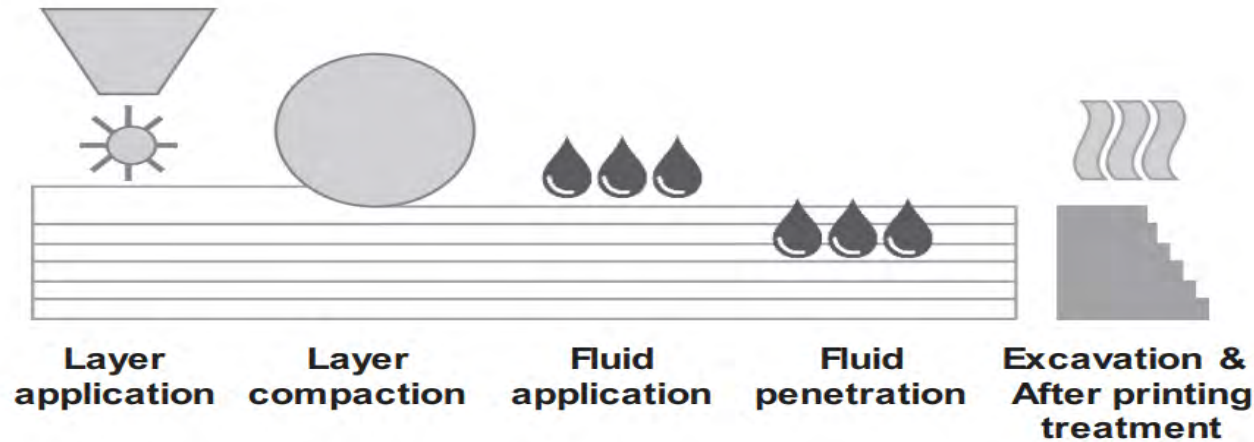

Picture: D. Lowke, I. Mai, E. Keita, A. Perrot, D. Weger, C. Gehlen, F. Herding, W. Zuo, N. Roussel – **Material-process interactions in particle bed 3D printing and the underlying physics** Cem. Concr. Res., 0008-8846, 156 (2022), p. 10674

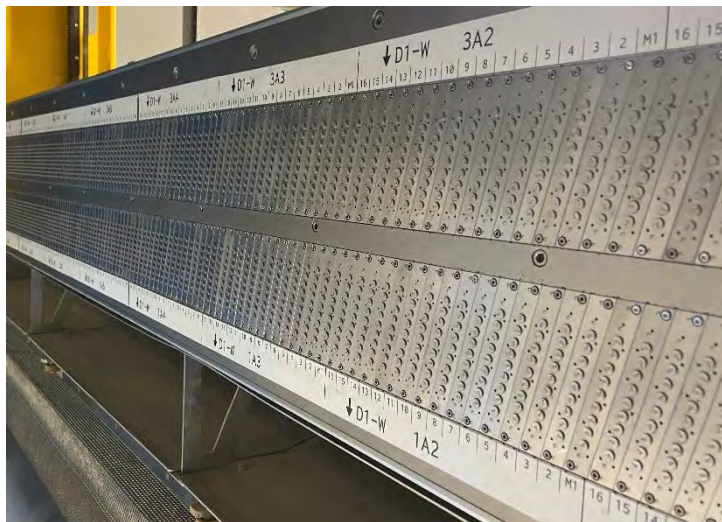

Requirements for new Materials

Powder Mixture:

- Shelf-Stable/Storable
- Reusable
- Good Solubility in Fluid

Fluid:

- Stable for 10 hours
- Low-Corrosive
- Viscosity below 300 cp
- No risk of clogging nozzles ($d=150\ \mu\text{m}$)
- No formation of hard residue

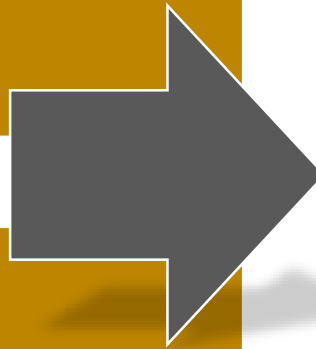

Resulting Material:

- Good early strength
- High final strength ($\sim 50\ \text{MPa}$)
- Low shrinkage
- Hardening at low temperature
- High-volume parts achievable
- Suitable for outdoor applications

Resulting and further Challenges

- Binder can not be prepared first
- No rotary mixing of the binder possible
- No watertight border: Fluid will migrate out of the part

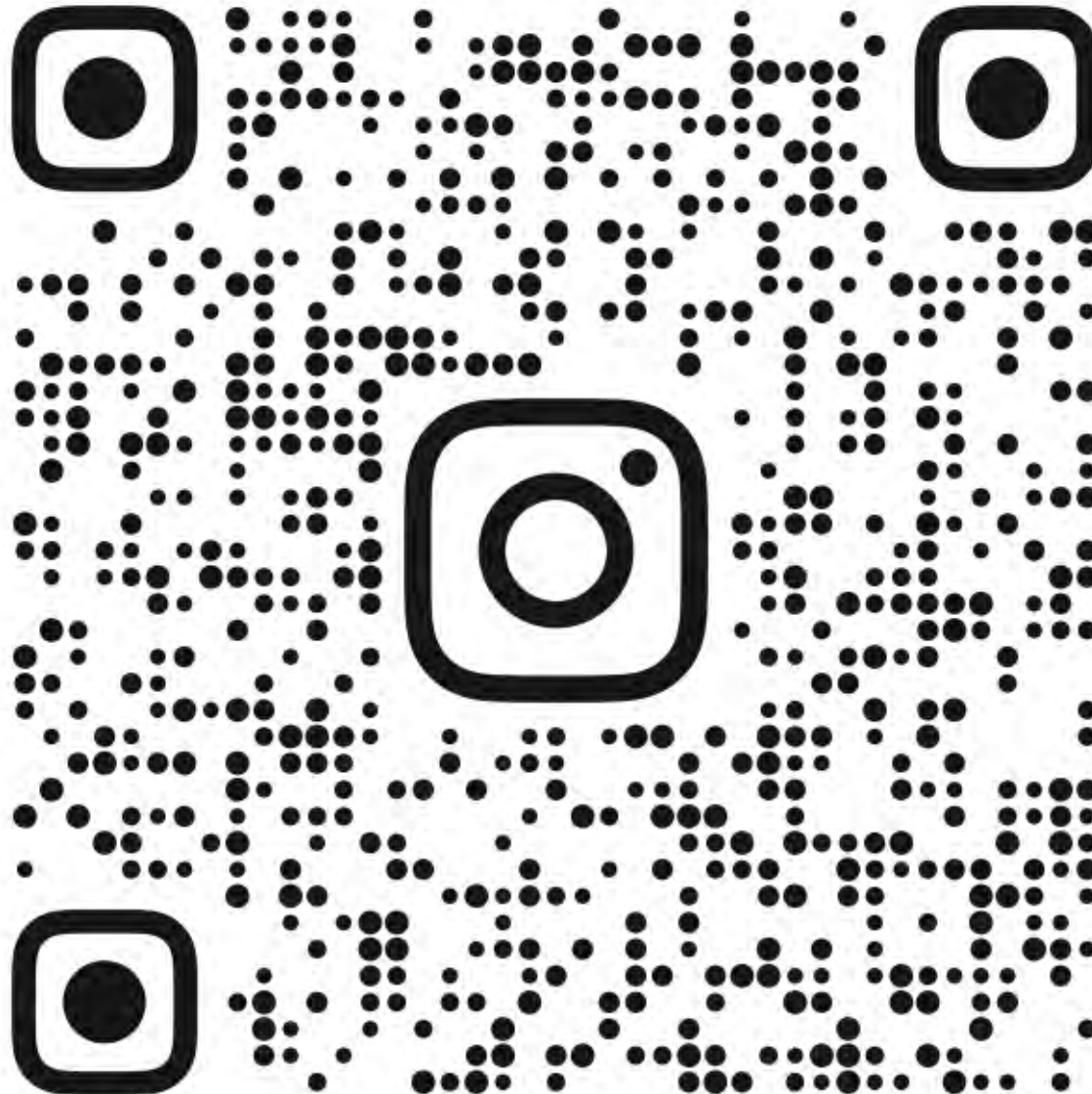

Bruno Knychalla, M.Sc.
Managing Director

Additive Tectonics GmbH
Am Grohberg 1
92331 Lupburg
Germany

Phone: +49 (0) 9492 9429 200

Fax: +49 (0) 9492 9429 11

Mobile: +49 (0) 171 314 957 0

Mail: bruno.knychalla@additive-tectonics.com